



Product Catalogue



Forming valuable enduring partnerships with our Trimax family.

Our belief at Trimax is that our customers are like family, and like family, we look out for each other. If you have a problem that needs solving then we're here to help in any way we can.

Our comprehensive range of commercial mowers has been designed with our family in mind, which means we're building machines that produce the best cut possible whilst ensuring you spend less time and money on maintenance.

DESIGNED & MANUFACTURED IN
NEW ZEALAND 



www.facebook.com/trimaxmowingsystems
www.trimaxmowers.co.nz



“The birth of Trimax had a lot to do with modern day kiwifruit production, which was pioneered in New Zealand during the 1970’s.

Whilst servicing the horticulture industry, Trimax gained demand for it’s machines in parks and reserves because of the product’s quality of cut and strong build.

We have now grown to be a market leading brand around the world and take pride in knowing and supporting our customers and dealer networks as we work together to drive new mowing innovations.”

- Bob Sievwright, Founder and CEO of Trimax Mowing Systems

1981

First production of Ezeemow, Mowcraft & Mulchmasta flail mowers.



1983

Pride, Procut and veemow disc mowers & the Procut S1 rotary roller mowers in production.



1985

First exports to Australia and a dedicated research and development department.



1991

Stealth S1 released.



1992

First exports to Great Britain & awarded best exporter of the year.



1993

Topper S1 released. Awarded exporter of the year.



1995

First exports to the United States.



1997

Windsor Castle and surrounding grounds start using the Trimax ProCut for their Maintenance.



1998

The opening of a Trimax distribution warehouse in Great Britain.



2001

The Pegasus S1 is released. First rotary roller mower in the USA for Fine Turf.



2011

30th Anniversary of Trimax observed.



2014

The Trimax Snake is released. A fully dedicated sports turf and municipality mower.



We'll keep you moving with our market leading **3 YEAR WARRANTY!**

Our warranty claims are less than 1%

The industry standard is over 2%. That means we build our mowers tough!

Call us now.
(07) 541 0411

parts@trimaxmowers.co.nz
sales@trimaxmowers.co.nz
www.trimaxmowers.co.nz

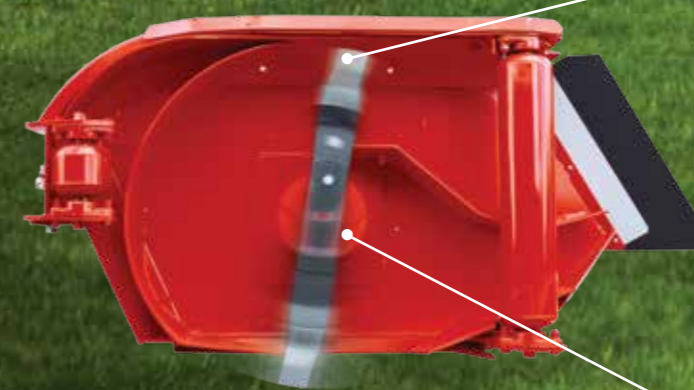

LazerBladez™

The offset mounting hole on the LazerBladez™ alters the centre of gravity of the blade causing it to 'tilt-forward' whilst cutting. This ensures that when the going gets tough you don't experience 'hang back', which results in strips of uncut grass.

LazerBladez™ are wider than similarly sized blades resulting in more mass and more impact in heavy going.

The carefully refined upturn on the blade's trailing edge gives better grass lift and discharge characteristics.

Spindles

Trimax spindles have been rigorously tested in real world conditions and have proved themselves to be bullet proof.

Spindles are included in our warranty policy.

LazerBladez™

*Standard warranty conditions apply.



“Mowing times have been reduced by 50% on our links course. The Snake is a brilliant machine for our fairways, with a very easy 10 minute adjustment to rough mowing height.”

- Brian Hateley – Course Convenor from Westport Golf Club.



“We get a nice clean cut with our Topper, which means you get good regrowth. I wouldn’t buy anything else.”

- Ian Wilcox – Farmer, Matamata.















“The school has had Trimax mowers for over 10 years now. They produce a pristine finish every time on both the cricket pitch and the rugby field. We’re completely happy with them and we wouldn’t look at another mower!”

- Chris Harris - Tauranga Boys College.



“Not only does it produce a great cut, but the large diameter rollers create a neat, crisply-striped finish, enhancing the appearance of every mown surface.”

- Jonathan Boot from Boot of Lydstep on his Trimax Pegasus S3 rotary mower.

	STRIKER Rotary Mower	8-9
	PROCUT S3 Rotary Mower	10-11
	PROCUT S3 Rotary Orchard Mower	12-13
	TOPPER Rotary Farm Mower	14-15
	SNAKE Rotary Mower	16-17
	STEALTH S3 Rotary Mower	18-19
	PEGASUS S4 Rotary Mower	20-21
	X-WAM Rotary Mower	22-23
	EZEEMOW FX Flail Mower	24-25
	FLAILDEK FX Flail Mower	26-27
	WARLORD S3 Flail Mower	28-29
	OFFSET GRAPHS Ezeemow FX and Warlord S3	31

Trimax has a policy of continuous improvement, therefore models may change without notice.



	Striker 150	Striker 190
Cutting Width	1460mm (57")	1940mm (76")
Overall Width	1560mm (61")	2040mm (80")
Cut Height Range	10-100mm (3/8" - 4")	10-100mm (3/8" - 4")
Height	825mm (32")	825mm (32")
No. of Blade Spindles	3	4
Approx. Weight	310kg	390kg
Minimum Tractor Size	25hp	30hp
Application	<div style="display: flex; justify-content: space-between; align-items: center;"> — ● — — ● ● — ● — — </div> <div style="display: flex; justify-content: space-between; font-size: 8px; margin-top: 2px;"> Municipality Horticulture Agriculture Turf Farm School Lifestyle Racecourse Sports Field Golf Aviation </div>	

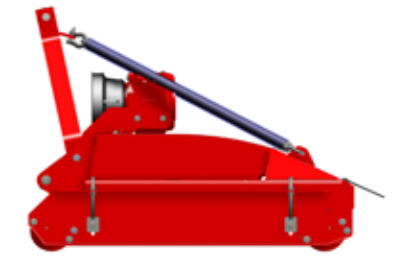

Features



3 YEAR WARRANTY

We aim to build mowers that last and we back this up with a 3 year warranty which includes the spindles and gearboxes. Our robust design coupled with our experienced service and support network ensures minimum downtime and more productivity.

LOW MAINTENANCE

With only 4 carefully positioned grease points and robust spindles with sealed ball bearings, the Trimax Striker has incredibly low maintenance requirements.

SAFETY

Striker exceeds international safety standards and is backed up by our meticulous testing and support network. Striker is a mower that can be used with confidence even when mowing in confined areas.

LAZERBLADEZ™

LazerBladez™ are fitted to enhance the clean cutting ability of the Striker. The tilt-forward design of LazerBladez™, which is unique to Trimax, minimises hang back in tough conditions and the full-length cutting edge ensures that a clean cut is achieved when mowing at high ground speeds. LazerBladez™ are made from a special alloy steel which provides greater durability needed in commercial mowing operations. The combination of more cuts per metre, LazerBladez™ and a unique under-body design ensures an even spread of clippings.

ADVANCED DESIGN

Striker incorporates decades of experience with multi-spindled rotary roller mowers. Lighter than other Trimax mowers, it retains the attention to detail that minimises downtime and makes servicing easy. The cutting system, body integrity and sealed ball bearing spindles have been proven with extensive and rigorous testing.

Striker

Rotary mower for compact tractors

Trimax Striker is a multi-spindled rotary mower with low maintenance requirements that incorporates a unique baffle design for improved grass distribution and less clumping.

Designed for tractors in the 25-45hp range, Striker has Trimax LazerBladez™ fitted as standard and has full-width front-and-rear rollers which produce an attractive striped pattern and guard against scalping.

Striker is designed to withstand tough conditions. It has variable height adjustment for year round mowing and an enclosed cutting chamber for added safety.

Able to mow quickly at a high standard, Striker is ideal for educational and sports facilities and green spaces where presentation is key.

Ask us how Striker can transform your environment.



“The grass was about 150mm high and wet, it went great, made a good even cut leaving an even spread of cut grass, we thought it was the best mower we had ever seen.”

Ian Dufty - Proud owner of a Trimax Striker

	P3 178	P3 210	P3 237	P3 290
Cutting Width	1742mm (69")	2060mm (81")	2316mm (91")	2890mm (114")
Overall Width	1884mm (74")	2200mm (87")	2460mm (97")	3130mm (123")
Height	1085mm (43")	1085mm (43")	1085mm (43")	1085mm (43")
Cut Height Range	10-110mm (3/8"-4 1/2")	10-110mm (3/8"-4 1/2")	10-110mm (3/8"-4 1/2")	10-110mm (3/8"-4 1/2")
No. of Blade Spindles	3	3	4	5
Approx. Weight	503kg	566kg	616kg	712kg
Minimum Tractor Size	40hp	45hp	50hp	55hp
Application				

Features



3 YEAR WARRANTY

We aim to build mowers that last and we back this up with a 3 year warranty which includes the spindles and gearboxes. Our robust design coupled with our experienced service and support network ensures minimum downtime and more productivity.

MULTIPLE SPINDLES

Over the past 30 years Trimax has mastered the art of high performance multi-spindle mowers. ProCut S3 spindles have smaller diameter blades that give more cuts per metre, clean cutting at high ground speeds. This adds up to better productivity and an exceptional finish.

LAZERBLADEZ™

LazerBladez™ are fitted to enhance the clean cutting ability of the ProCut S3. The tilt-forward design of LazerBladez™, which is unique to Trimax, minimises hang back in tough conditions and the full-length cutting edge ensures that a clean cut is achieved when mowing at high ground speeds. LazerBladez™ are made from a special alloy steel which provides greater durability needed in commercial mowing operations.

FULL WIDTH ROLLERS

Large diameter front and rear rollers on the ProCut S3 follow contours and support the mower across its entire width, providing excellent anti-scalp protection. The mower decks are able to be hung over kerbs and run across concrete areas with no fear of blade strikes.

Options

QUATTRO BLADE SYSTEM

This system adds 2 more blades to each spindle (2 flat, 2 upturned) for a finer cut on warm season grasses. (Currently unavailable on the 210 model)

FRONT MOUNT OPTION

ProCut S3 can be specified in a front mount configuration.



FITTED WITH **LazerBladez™**

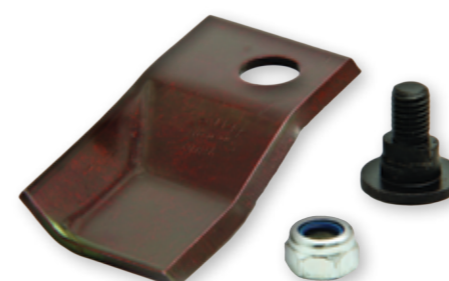

ProCut S3

High performance roller mower

The Trimax ProCut Series 3 is a highly versatile roller mower. This robust machine has been engineered to withstand everyday use in the toughest commercial environments, yet will deliver a cylinder like cut – every time.

ProCut has been a successful part of the Trimax range for nearly 30 years, mowing parks & reserves, school grounds and sports fields throughout the world. The ProCut S3 offers new features, improved performance and is easier to maintain, yet retains many of the aspects that set the original apart from the competition.

Talk to us today about the capabilities of ProCut in your environment.



	P3 178	P3 210	P3 237	P3 290						
Cutting Width	1742mm (69")	2060mm (81")	2316mm (91")	2890mm (114")						
Overall Width	1884mm (74")	2200mm (87")	2460mm (97")	3130mm (123")						
Height	1085mm (43")	1085mm (43")	1085mm (43")	1085mm (43")						
Cut Height Range	10-110mm (3/8"-4 1/2")	10-110mm (3/8"-4 1/2")	10-110mm (3/8"-4 1/2")	10-110mm (3/8"-4 1/2")						
No. of Blade Spindles	3	3	4	5						
Approx. Weight	503kg	566kg	616kg	712kg						
Minimum Tractor Size	40hp	45hp	50hp	55hp						
Front Mount	Optional	Optional	Optional	Optional						
Application	●	●	—	—	—	●	●	—	—	●
	Municipality	Horticulture	Agriculture	Turf Farm	School	Lifestyle	Racecourse	Sports Field	Golf	Aviation

Features



3 YEAR WARRANTY

ProCut S3 is backed by our market leading 3 year warranty which includes the spindles

MULTIPLE SPINDLES

Over the past 30 years Trimax has mastered the art of high performance multi-spindle mowers. ProCut S3 spindles have smaller diameter blades that give more cuts per metre, clean cutting at high ground speeds. This adds up to better productivity and an exceptional finish.

LAZERBLADEZ™

LazerBladez™ are fitted to enhance the clean cutting ability of the ProCut S3. The tilt-forward design of LazerBladez™, which is unique to Trimax, minimises hang back in tough conditions and the full-length cutting edge ensures that a clean cut is achieved when mowing at high ground speeds. LazerBladez™ are made from a special alloy steel which provides greater durability needed in commercial mowing operations.

FRONT MOUNT OPTION

ProCut S3 can be specified in a front mount configuration.

ProCut S3

Single roller rotary orchard mower

The original ProCut found phenomenal success in orchard mowing applications due to its rigid construction, low maintenance and manoeuvrability.

The ProCut S3 utilises a low body profile and is available in 4 different cutting widths. The enlarged rear roller runs smoothly over bumps to give a more even finish and provide anti-scalp protection.

The underbody design has increased clearance which improves clipping distribution. Roller bearings have been mounted inboard for better protection and remote grease points allow for easy lubrication of spindles and bearings.

Multiple blade spindles give more cuts per meter at high travel speeds. Add to this the superb cutting performance of Trimax's unique LazerBladez™ system and you have a mower that excels in even the harshest conditions.



FITTED WITH **LazerBladez™**

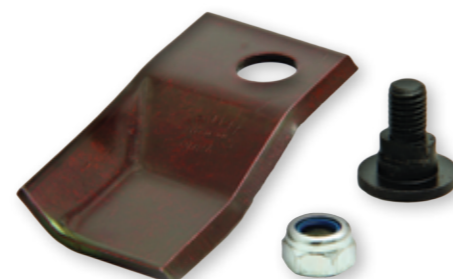

	Topper 237	Topper 282
Cutting Width	2316mm (91")	2740mm (107")
Overall Width	2460mm (97")	2880mm (113")
Overall Length	1316mm (51")	1240mm (48")
Cut Height Range	20-160mm (3/4" - 5")	20-160mm (3/4" - 5")
No. of Spindles	4	4
Approx. Weight	590kg	605kg
Minimum Tractor Size	45hp	50hp
Application	<div style="display: flex; justify-content: space-between; width: 100%;"> Municipality Horticulture Agriculture Turf Farm School Lifestyle Racecourse Sports Field Golf Aviation </div>	



Features

3 YEAR WARRANTY

We aim to build mowers that last and we back this up by a 3 year warranty which includes the spindles and gearboxes. Our robust design coupled with our experienced service and support network ensures minimum downtime and more productivity.



ADVANCED DESIGN

Topper is short front to rear and mounts close to the tractor; this allows the use of smaller tractors for a large cut width and a smaller turning radius for better manoeuvrability. The high under body clearance and open deck design allow good flow of grass into the mowing deck and a clean ejection of cut grass.

LAZERBLADEZ™

Each Topper spindle has 2 LazerBladez™ mounted on a spring steel blade beam. The smaller diameter blades turning at high speed mean more cuts per forward meter of travel, allowing a finer cut, which improves regrowth and pasture quality - essential for improved milk production.

Options

REAR ROLLER

The Topper can be fitted with a rear roller, which ensures that in undulating farm environments you'll have increased protection from impact damage.

ANTI-SCALPING DISCS

For further protection against scalping on uneven surfaces, anti-scalping discs that can be bolted onto the spindles beneath the blades are available.



"We use the Topper to keep up the quality of the grass behind the cows. The farm tends to grow a lot of grass early on in the season and it's hard to control, even with silage, so we top to keep the quality up. We get a nice clean cut which means you get good regrowth. I wouldn't buy anything else."

Ian Wilcox – Farmer, Matamata



- ✓ Improves feed quality
- ✓ Increases farm profitability
- ✓ Increases MS production
- ✓ Promotes faster re-growth



Topper™

Dedicated pasture topper

The Trimax Topper cuts pasture grass quickly and efficiently. Small diameter blades turning at high speed mean more cuts per meter of travel and less distance to move cut material before it is ejected. Very high under-body clearance guarantees low horsepower requirements and Trimax's exclusive Anti Block System (ABS) prevents frustrating blockages around spindles in extreme conditions.

The Trimax Topper is short from front to rear to minimise leverage and is mounted close to the tractor. This allows the use of smaller tractors for large cut widths and a smaller turning radius for easier access into tight corners.

Talk to us today about how Topper can benefit you in your environment.

FITTED WITH **LazerBladez™**

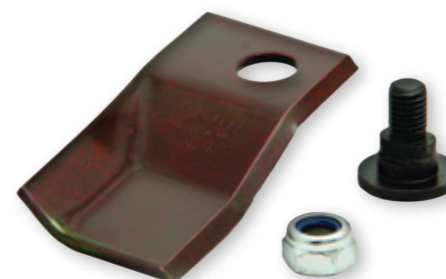



Snake

3.2m width for compact tractors

Snake is the accumulation of over 30 years of Trimax innovation, engineering and customer insight. Designed for sports turf and golf courses, Snake has the unique ability to transform a variety of conditions into an even carpet of green.

We've seamlessly combined our world class cut quality and have added articulation capabilities never seen before on a Trimax mower.

Built for agility, and incredibly robust, the Trimax Snake won't fail to impress. Snake owners benefit from a proven 3 year warranty and genuine Trimax support.

Talk to us today about the capabilities of Snake in your environment.



"We call our Trimax Snake the 'game changer'. Mowing times have been reduced by 50% on our links course. It's a brilliant machine for our fairways, with a very easy 10 minute adjustment to rough mowing height. The rollers are fantastic for smoothing out the bumps and scars on the fairways and the rotary cut is impressive – no stalks remaining!"

Brian Hateley – Course Convenor from Westport Golf Club

	Snake
Cutting Width	3234mm (127")
Overall Width	3372mm (133")
Width (transport mode)	2050mm (81")
Cut Height Range	10-90mm (3/8"-3 1/2")
Height (transport mode)	1860mm (73")
No. of Blade Spindles	9
Approx. Weight	1240kg
Minimum Tractor Size	40hp
Application	<div style="display: flex; justify-content: space-around; align-items: center;"> ● — — ● ● — — ● ● — </div>



Municipality Horticulture Agriculture Turf Farm School Lifestyle Racecourse Sports Field Golf Aviation

Features



3 YEAR WARRANTY

We aim to build mowers that last and we back this up by a 3 year warranty which also includes the spindles and gearboxes. Our robust design coupled with our experienced service and support network ensure minimum downtime and more productivity.

KERB JUMP

The Kerb Jump, also known as 'Cross Cut', enables all three mower decks to be raised just off the ground without disengaging the PTO. This improves productivity by allowing the mower to traverse gravel driveways or paths and quickly turn at headlands.

ZERO TURN

Continuous cutting while turning for areas such as headlands, tight spaces and around trees.

LAZERBLADEZ™

Snake is fitted with Trimax LazerBladez™, a blade system with a carefully engineered centre of gravity and distinctive tilt-forward blade design unique to Trimax. Utilising the LazerBladez™ full length cutting edge, Snake produces a clean finish even when mowing at high ground speeds. LazerBladez™ are made with high grade alloy steel providing a significant increase in blade and bolt life for added safety and lower operating costs.

FULL WIDTH ROLLERS

Full width rollers minimises scalping in extreme undulating conditions and allows mowing over kerbsides, bunkers and potholes without blade strike.

UP TO 50HR PTO GREASE

With the use of our new FLEX CONE, we can help prevent dust and external agents getting trapped in the bearings, also minimising the risk of PTO's coming in contact with the rotating parts of the drives. This greatly reduces the amount of greasing required, extending intervals out to as much as 50 hours.

Options

ROADKIT

The road kit option adds mudguards to the wheels and includes LED tail light clusters.

REMOTE UNLOCK

The remote unlock option replaces the standard transport lock release rope with an electric actuator. This is operated by a push-button on the tractor.



Features



3 YEAR FACTORY-BACKED WARRANTY

We build mowers that last. Our market leading 3 year warranty proves we stand behind our products and you can have confidence in your purchase decision.

REVOLUTIONARY MAINTENANCE-FREE ROLLER BEARING DESIGN

Featuring heavy duty Tri-bolt housings, large triple sealed bearings, replaceable stubs and simple, yet robust patent pending* roller retention. Our innovative roller bearings require no maintenance greasing and have a longer lifespan than any previous Stealth.

STAND-ON COVERS

Provides safe and easy access to the rear of the tractor when coupling the mower.

REDUCED MAINTENANCE

We've eliminated the need for daily greasing through many new features. Our revolutionary new roller bearing design is proven to require fewer bearing replacements and our updated spindle technology requires less maintenance and offers greater simplicity. You can spend more time mowing and less time maintaining!

EASY TO CLEAN

The improved belt chamber design results in easy cleaning, with the front openings allowing the grass to be easily washed or blown out.

MOST VERSATILE STEALTH EVER

The improved cutting chamber design means a much improved quality of cut and spread in long and short grass. The new baffle design directs airflow from the blades out and over the rear roller, making the Stealth S3 the most versatile Stealth ever.

EASY, ACCURATE HEIGHT ADJUSTMENT

Clearly displayed cut height indicators allow for simple and easy alteration or resetting of cut heights. You can adjust heights without having to raise and lower the wings.

LAZERBLADEZ™

Stealth S3 is fitted with Trimax LazerBladez™, a blade system with a carefully engineered centre of gravity and distinctive tilt-forward blade design unique to Trimax. For optimum performance and grass spread.



Stealth S3

The most versatile Stealth ever

Introducing the New Trimax Stealth S3, the most versatile Stealth ever. Designed to have a higher quality of cut, operate in a wider range of conditions, be safer, more robust, easier to operate and take less time to maintain than any previous Stealth.

The concept of Stealth S3 was born from the demand of our customers for a mower that was more versatile in terms of long grass performance and more user friendly for both the operator and the workshop.

After over 18 months of feedback, field trials and testing, we bring you the Stealth S3, designed by you and built by us.

Ask us how Stealth S3 can transform your environment.

Options

INDIVIDUAL WING LIFT/ELECTRIC UNLOCK

Individual wing lift feature to lift either the left or right decks independently.

ROLLER SCRAPERS

Trimax Helical scrapers ensure constant pressure on the roller and assist with cleaning.

SAFETY STANDS

Lockable stands that hold the mower up to assist with maintenance.

SAFETY AND STORAGE KIT

Includes toolbox, road lights, safety triangle and mounting bracket for commercial use.

Stealth S3

Cutting Width	3400mm (134")
Overall Width	3550mm (140")
Width (transport mode)	2416mm (95.2")
Height (transport mode)	1205mm (47.5")
Cut Height Range	10-90mm (0.4 - 3.5")
No. of Blade Spindles	5
Approx. Weight	940kg (2070 lbs)
Minimum Tractor Size	60hp
Warranty (Years)	3



Application	●	—	—	●	●	—	●	●	●
	Municipality	Horticulture	Agriculture	Turf Farm	School	Lifestyle	Racecourse	Sports Field	Golf

*NZ Pat. App. No. 707193

To view more videos visit www.trimaxmowers.co.nz



Pegasus S4

The lowest maintenance Pegasus ever

After fifteen years in the market, Pegasus has established itself as the benchmark in wide-area mowing for parks, reserves, airports, racetracks, sports fields and turf farms.

Available in 4.9m and 6.1m widths, the S4 is our newest version of the exceptionally low-maintenance trailed rotary mower.

Engineered to be the lowest maintenance Pegasus ever, the number of grease points on the S4 have been reduced by 30%. It also comes with sealed, maintenance-free spindles and fully sealed roller bearings, all of which have at least halved the annual maintenance hours and costs.

The development of the Pegasus S4 is a great example of how we push technologies through our entire product range and it will give you rock-solid reliability, strength and performance.

Call us today for a demonstration of the Pegasus S4 and see for yourself how it can transform your environment.



	G3 493	G3 610
Cutting Width	4926mm (194")	6074mm (239")
Overall Width	5082mm (200")	6230mm (245")
Transport Mode	2500mm (98")	2500mm (98")
Overall Length	4320mm (170")	4320mm (170")
Cut Height Range	10-90mm (3/8"-3 1/2")	10-90mm (3/8"-3 1/2")
No. of Spindles	9	11
Approx. Weight	2200kg	2400kg
Minimum Tractor Size	50hp	55hp
Application		



Features



3 YEAR WARRANTY

We aim to build mowers that last and we back this up by a 3 year warranty which also includes the spindles and gearboxes. Our robust design coupled with our experienced service and support network ensure minimum downtime and more productivity.

LOW MAINTENANCE

The number of grease points have been reduced from 75 (on the S3) to just 52 on the S4. That's a 30% reduction in grease points, and a 90% reduction in grease consumption. It also comes with sealed maintenance free spindles and fully sealed roller bearings that need no maintenance at all.

LAZERBLADEZ™

Trimax's famous LazerBladez™ fling-tip blades are fitted as standard on the Pegasus S4, which help achieve a superior cut finish through an optimised blade thickness and air flow, a carefully engineered centre of gravity and unique 'tilt forward' blade system. LazerBladez™ are much more cost efficient than (reel or) solid beams as only the fling-tip portion of the blade is replaced.

FULL WIDTH ROLLERS

Full width rollers on all decks follow the contours of the ground and provide excellent anti-scalp protection. Rollers also allow mowing along the edge of banks or paths and produce a superb striping effect for those wishing to pattern their turf. Safety is enhanced as rollers contain debris in the cutting chamber.

MAINTENANCE FREE SPINDLES

To ensure optimum efficiency, the Pegasus S4 is fitted with sealed, maintenance free spindles, which removes the need for regular greasing and gives you more time for cutting.

Options

ILS

The ILS (individual lift system) allows independent lift of either side deck for reduced cutting width when operating in confined spaces without leaving the tractor seat.

QUATTRO BLADE SYSTEM

This system adds 2 more blades to each spindle (2 flat, 2 upturned) for a finer cut on warm season grasses.

REMOTE UNLOCK

The remote unlock option replaces the standard transport lock release rope with an electric actuator. This is operated by a tractor mounted controller.

ROLLER SCRAPERS

Trimax Helical scrapers operate with reduced tension but apply constant pressure on the roller to assist with cleaning.

ELECTRIC BRAKES

Electric brakes will reduce the braking force needed from the tractor. The electric brake option includes an adjustable brake controller with proportional boost for improved performance, and a lockout switch so the brakes can be de-activated while mowing.

ANTI-BOUNCE SKIDS

Developed to eliminate the 'scalping' effect when mowing on turf where the ground is not perfectly smooth. Helps to ease the mower over humps between the front and rear rollers.

XWAM 1040

Cutting Width	10410mm (410")																						
Overall Width	10540mm (415")																						
Transport Mode	2740mm (108")																						
Overall Length	5500mm (217")																						
Cut Height Range	10-110mm (3/8"-4 1/2")																						
No. of Spindles	19																						
Approx. Weight	4880kg																						
Minimum Tractor Size	90hp																						
Application	<table border="0"> <tr> <td>—</td><td>—</td><td>—</td><td>●</td><td>—</td><td>—</td><td>—</td><td>●</td><td>—</td><td>●</td><td>●</td> </tr> <tr> <td>Municipality</td><td>Horticulture</td><td>Agriculture</td><td>Turf Farm</td><td>School</td><td>Lifestyle</td><td>Racecourse</td><td>Sports Field</td><td>Golf</td><td>Aviation</td><td></td> </tr> </table>	—	—	—	●	—	—	—	●	—	●	●	Municipality	Horticulture	Agriculture	Turf Farm	School	Lifestyle	Racecourse	Sports Field	Golf	Aviation	
—	—	—	●	—	—	—	●	—	●	●													
Municipality	Horticulture	Agriculture	Turf Farm	School	Lifestyle	Racecourse	Sports Field	Golf	Aviation														



Features



3 YEAR WARRANTY

We aim to build mowers that last and we back this up by a 3 year warranty which also includes the spindles and gearboxes. Our robust design coupled with our experienced service and support network ensure minimum downtime and more productivity.

LAZERBLADEZ™

X-WAM is fitted with Trimax LazerBladez™, a blade system with a carefully engineered centre of gravity and distinctive tilt-forward blade design unique to Trimax. Utilising the LazerBladez™ full length cutting edge, X-WAM produces a clean finish even when mowing at high ground speeds. LazerBladez™ are made with high grade alloy steel providing a significant increase in blade and bolt life for added safety and lower operating costs.

LOW MAINTENANCE

Ease of maintenance and reliability are engineered into the X-WAM design. All moving surfaces have long-life synthetic bushes or greasable bearings. Remote grease points are centralised and raising the mower decks provides unobstructed access to the mower under-body for safe and hassle-free maintenance.

“Trimax X-WAM is great equipment. It replaced one tractor, one employee and reduced mowing time. Less equipment to maintain and less equipment expense has increased our profitability.”

Lynn Gibb - Hope Plantation Turf



X-WAM™

Ultimate wide area mowing when quality counts

The X-WAM has superior contour-following abilities based on the unique combination of individually floating decks and articulated axis. With the potential to cut 33 acres per hour and the ability to perform zero-turns without having to lift any of the mower decks, the X-WAM will increase your productivity using one tractor, one driver, and one mower to cut 2/3 more area with a cylinder-like cut finish.

Talk to us today about the capabilities of X-WAM in your environment.



Ezeemow^{FX}

Trimax flail technology for compact tractors

The new Ezeemow FX is the ideal partner for your compact tractor where versatility and robustness is needed. Ezeemow FX has been designed to give you greater mowing versatility from short grass to heavy conditions.

Ezeemow FX can handle fine turf, small prunings and one meter high grass and scrub with minimal maintenance and maximum reliability.

This versatility makes the Ezeemow FX ideal for contractors, councils, roadsides, estates and orchard applications. Ezeemow FX is compatible with tractors from 20 to 45hp and its compact dimensions allow manoeuvrability in tight corners.

Talk to us today about Ezeemow FX for your environment.



	EFX 135	EFX 155	EFX 185
Cutting Width	1342mm (53")	1520mm (60")	1830mm (72")
Overall Width	1560mm (61")	1720mm (68")	2045mm (81")
Overall Length	583mm (23")	583mm (23")	583mm (23")
Cut Height Range	10-110mm (3/8"-4 1/2")	10-110mm (3/8"-4 1/2")	6-96mm (1/4"-4")
Approx. Weight	180kg	200kg	225kg
Minimum Tractor Size	20hp	20hp	24hp
Application			

Features



3 YEAR WARRANTY

We aim to build mowers that last and we back this up by a 3 year warranty. Our robust design coupled with our experienced service and support network ensure minimum downtime and more productivity.

RUGGED CONSTRUCTION

Well thought out design, high strength materials and robust monocoque construction ensure the Ezeemow can withstand the harshest conditions and the most demanding operators.

SAFETY FIRST

Safety is of paramount importance when mowing in public areas such as parks, schools and roadsides. This is why Trimax has designed the Ezeemow to expel debris in a downward direction behind the mower.

POWER SAVING FLAILS

The aerodynamic shape of Trimax's unique Gamma™ flails means the tractor's power is used for cutting grass or shredding vegetation, not for pumping air. This equates to lower horsepower requirements, allowing this mower to operate in difficult conditions when powered by a compact tractor.

FIXED OFFSETS AVAILABLE

Ezeemow FX is available in a number of fixed offset positions. View the offset positions on page 31.

Options

UNIQUE CONVERTER™

Trimax's unique and Patented Converter feature when lowered, allows superb short grass cutting ability by creating airflow that lifts the grass before it's cut. For work in heavy environments the Converter can be quickly lifted allowing more grass to be processed within the mower to increase productivity.



	FXU 135	FXU 155	FXU 185
Cutting Width	1342mm (53")	1520mm (60")	1830mm (72")
Overall Width	1560mm (61")	1720mm (68")	2045mm (81")
Overall Length	1095mm (43")	1095mm (43")	1095mm (43")
Cut Height Range	12-102mm (½"-4")	12-102mm (½"-4")	12-102mm (½"-4")
Approx. Weight	210kg	225kg	250kg
Minimum Power	Specific tractors only		
Hydraulic Drive	N/A	Optional	N/A
Application			

Features



3 YEAR WARRANTY

We aim to build mowers that last and we back this up with a 3 year warranty. Our robust design coupled with our experienced service and support network ensures minimum downtime and more productivity.

UNIQUE CONVERTER™

Trimax unique and Patented Converter feature when lowered allows superb short grass cutting ability by creating airflow that lifts the grass before it's cut. For work in heavy environments the Converter can be quickly lifted allowing more grass to be processed within the mower to increase productivity.

REAR ROLLER

The full-width rear roller prevents unsightly scalping and permits the edge of the mower to be run along kerbs and banks without fear of blade strike. The roller also adds to overall safety and produces a brilliant striping effect for those wishing to pattern their turf.

POWER SAVING FLAILS

Trimax's exclusive Gamma™ Flail offers a perfectly uniform cut with clippings finely chopped and dispersed behind the mower. The aerodynamic design reduces horse power requirements by ensuring that power is used for cutting grass rather than pumping air.



FlailDekFX™

Flail mower attachment for out front tractors

The Trimax FlailDek FX offers a high performance alternative to the standard factory-fitted rotary mowing attachments found on John Deere, Kubota, Iseki, New Holland, Shibaura and Hustler out-front tractors. With the ability to deliver an exceptionally clean cut and disperse clippings safely, FlailDek FX is suitable for sports grounds, roadsides, schools, parks and other fine turf applications.

Talk to us today about the capabilities of FlailDek FX in your environment.



	WS3 175	WS3 205	WS3 235
Cutting Width	1740mm (69")	2040mm (80")	2340mm (92")
Overall Width	2036mm (80")	2336mm (92")	2636mm (104")
Overall Length	1050mm (41")	1050mm (41")	1050mm (41")
Cut Height Range	10-100mm (3/8"-4")	10-100mm (3/8"-4")	10-100mm (3/8"-4")
Approx. Weight	660kg	750kg	800kg
Minimum/Maximum Power	45-100hp	50-100hp	55-100hp
Rollers	1	1	1
Flails per mower	24	28	32
Application			

Features



3 YEAR WARRANTY

We stand behind our products in the most demanding conditions and we are proud to offer Warlord S3 with a market leading 3 year warranty.

HYDRAULIC SIDE SHIFT

The Warlord S3 can be positioned directly behind the tractor or quickly offset by up to 500mm. This is perfect for transport and for manoeuvring around obstacles.

DISCHARGE CONTROL

The coarseness of the mulch is controlled by the height of the rear flap. The finest mulch is produced with the flap in its lowest position. Lifting the flap allows more material to be processed. Controlling the discharge also assists with safety in public spaces. Lifting the flap fully open makes for easier flail servicing.

PRUNING GUIDE

The guide helps direct prunings and other foliage, that would otherwise be too high to fit through the front aperture, in and under the Warlord. It also helps keep debris away from the hydraulic system for protection in challenging environments.

INTERNAL LINER

A 6mm replaceable internal liner increases the life of the body, minimises damage and reduces noise.

Options

HEAVY DUTY ROLLER

Upgrade from the 5mm thick roller to an 11mm heavy duty roller for more demanding applications.

LEFT-HAND OFFSET

Warlord can be specified with left-hand offset. See offset graphs on page 31 for configurations.

HEAVY DUTY SKIDS

The replaceable skids are ideal for operations where one side of the machine commonly runs on hard terrain.

Warlord S3™

Heavy duty flail mulcher mower

The all new Trimax Warlord S3 with its hydraulic sideshift operation makes for a perfect working companion in various conditions. Able to shred branches of up to 75mm in diameter, the Warlord S3 will turn shelter belt trimmings and orchard offcuts into the finest mulch. With the added ability of manoeuvring the mower around trees and obstacles, you can't go past the Warlord S3 for orchards, municipal and contracting operations.

Talk to us today about the capabilities of Warlord in your environment.





3
Year
Warranty

Our warranty claims are less than 1%

The industry standard is over 2%. That means we build our mowers tough! Because of this, we're proud to offer our 3 year warranty on all of our flail mowers.



Offset Graphs



Warlord S3™
Hydraulic Side Shift

Left hand offsets available

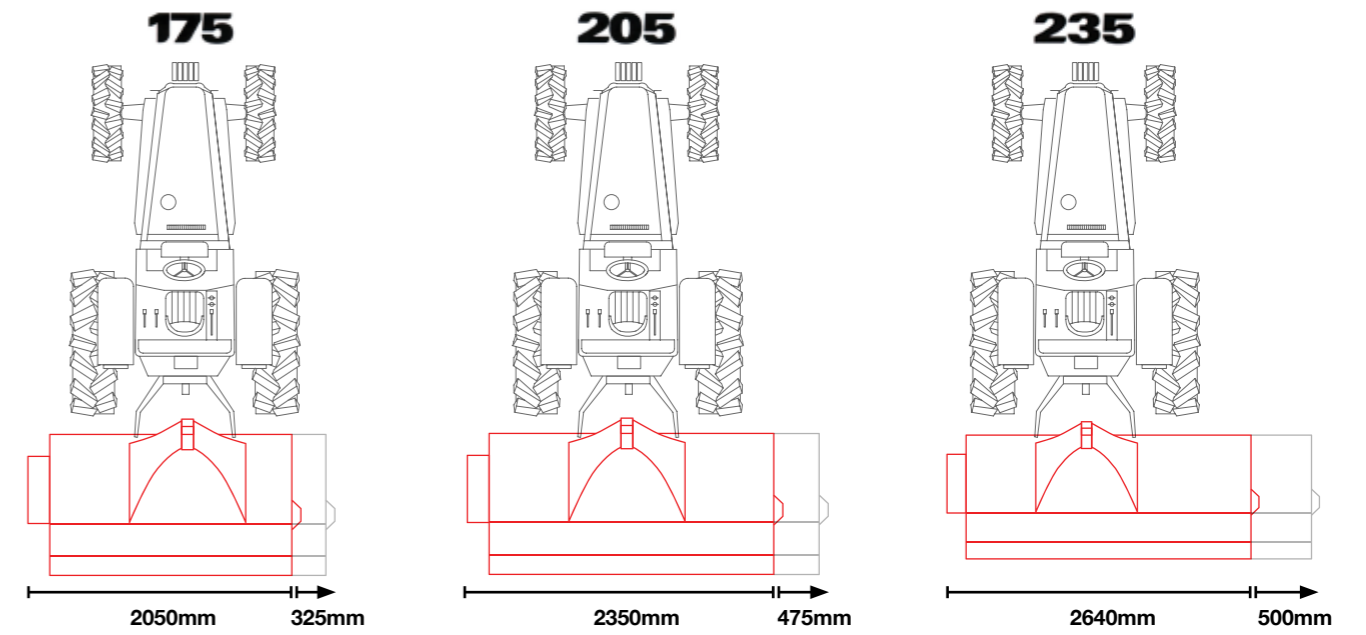

Ezeemow FX™

Fixed Offset Available

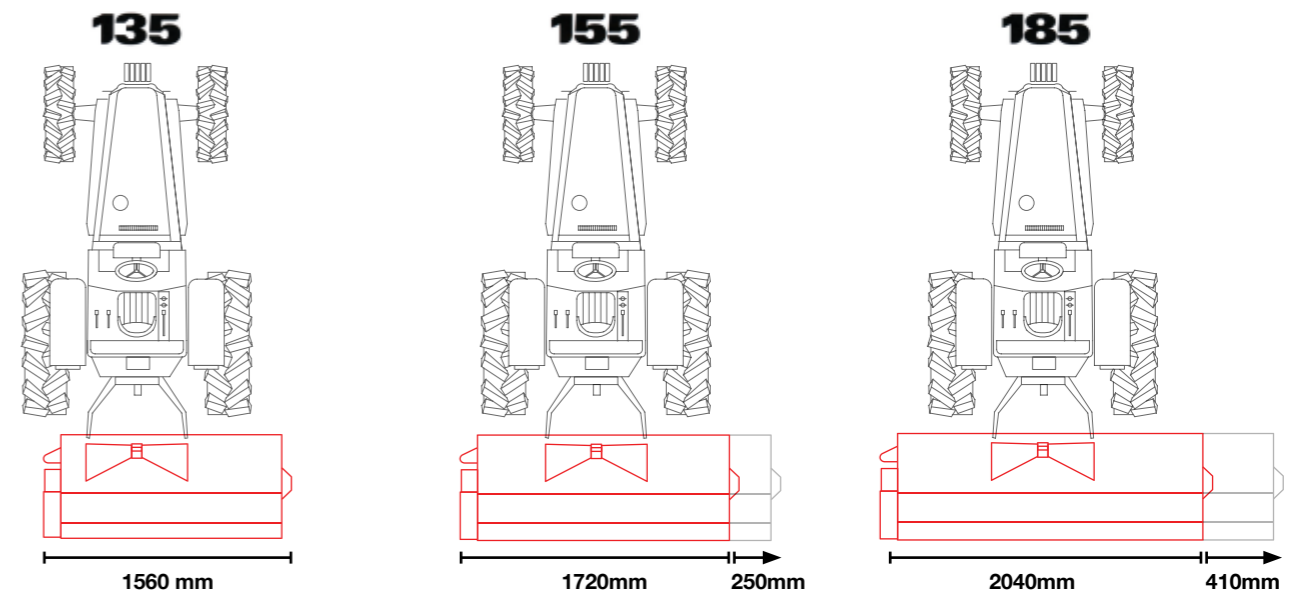

Please note Ezeemow is only available in fixed offset positions.



70 Maleme Street,
Tauranga 3140
Phone. 07 541 0411
email: info@trimaxmowers.co.nz
www.trimaxmowers.co.nz

Your nearest authorised dealer:

NZL4